

HURRICANE MANUAL FOR MARINE INTERESTS

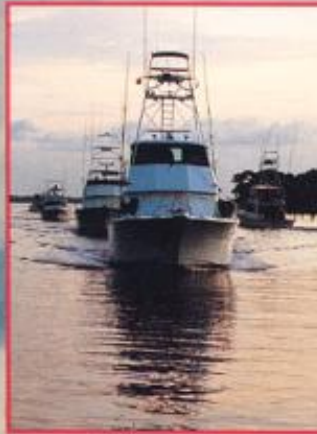

FLORIDA INLAND NAVIGATION DISTRICT

ACKNOWLEDGEMENTS

The Florida Inland Navigation District would like to acknowledge the following individuals and agencies whose materials were used in the development of this manual.

- Ted Crosby, CMS, AMIM, Area Marine Manager, CIGNA Loss Control Services, “Hurricane Precautions for the Yachting Community”.
- Dewayne Hollin and Ken Pagans, Texas A & M University, Sea Grant College Program, “Protecting Your Boat Against Severe Weather”.
- Boat/U.S. Seaworthy, “A Guide to Preparing Boats and Marinas for Hurricanes”.
- Richard E. Briggs and Donald W. Pybas, The Marine Council and Florida Sea Grant Program, “Boat Owners Hurricane Protection Guide”.

Funding for the development of this manual was provided by:

- Florida Inland Navigation District
- Florida Department of Environmental Protection Boating Improvement Program
- The South Florida Water Management District

Funding for the publication of this manual was provided by:

**Florida Inland Navigation District
1314 Marcinski Road
Jupiter, FL 33477-9498
(561) 627-3386**

Introduction

Florida is one of the most hurricane vulnerable areas on the United States Atlantic Coast. Recent hurricanes have shown that many vessel owners and other marine interests lack the knowledge and do not have a plan in place to properly prepare their vessel or marine facility for an approaching storm. The tragic aftermath of the destruction of vessels and marine facilities by the recent hurricanes mandate that vessel owners and marine facilities prepare a hurricane plan well in advance of the approach of a hurricane to Florida.

About 25 percent of hurricane fatalities result from boaters trying to secure vessels in deteriorating storm conditions.

The suggestions and information offered in this manual are intended to preserve life and property, but it is the boat and/or marina owner's responsibility to take precautionary measures to protect property when disaster threatens. The agencies contributing to this publication can assume no responsibility for actions taken by the boat/marina owner/operator.

Development has reduced the creeks, inlets and canals which boaters used as "hurricane holes" and refuges. With most old hurricane options no longer available and greater numbers of boats needing assistance, how can boaters or marina operators locate information to determine their best course of action?

The most important issue in hurricane preparation is to MAKE A PLAN.

Know what you are going to do and do it early, before the winds start to blow. The following pages will suggest many options and ideas. Choose some of these for YOUR PERSONAL PLAN for hurricane safety for you, your family, and your vessel.

The Florida Inland Navigation District, in cooperation with both public and private marine agencies, have developed this manual to provide boaters and marina operators with updated and reliable information to help guide their actions.



Failure to heed the information in this manual could result in a similar scene. Do not let this happen to your boat!

TABLE OF CONTENTS

Introduction	page 1
General hurricane information	page 3
Severe weather terms	page 3
General precautions for boat owners	page 4
Trailerable boats	page 4
Non-trailerable boats in dry storage	page 5
Non-trailerable boats in wet storage	page 5
Boats remaining in marina berths	page 5
Nautical knots	page 5
Specific precautions for boat owners	page 6
Prior to hurricane season	page 6
Prior to the hurricane	page 7
During the hurricane	page 8
After the hurricane	page 8
Specific precautions for marina owners	page 9
Prior to the hurricane season	page 9
Prior to the hurricane	page 9
During the hurricane	page 10
After the hurricane	page 10
Tying to cleats and pilings	page 11
General procedures to process vessel claims	page 12
Boat owners preparation worksheet	page 13
Summary	page 14
Notes	page 15

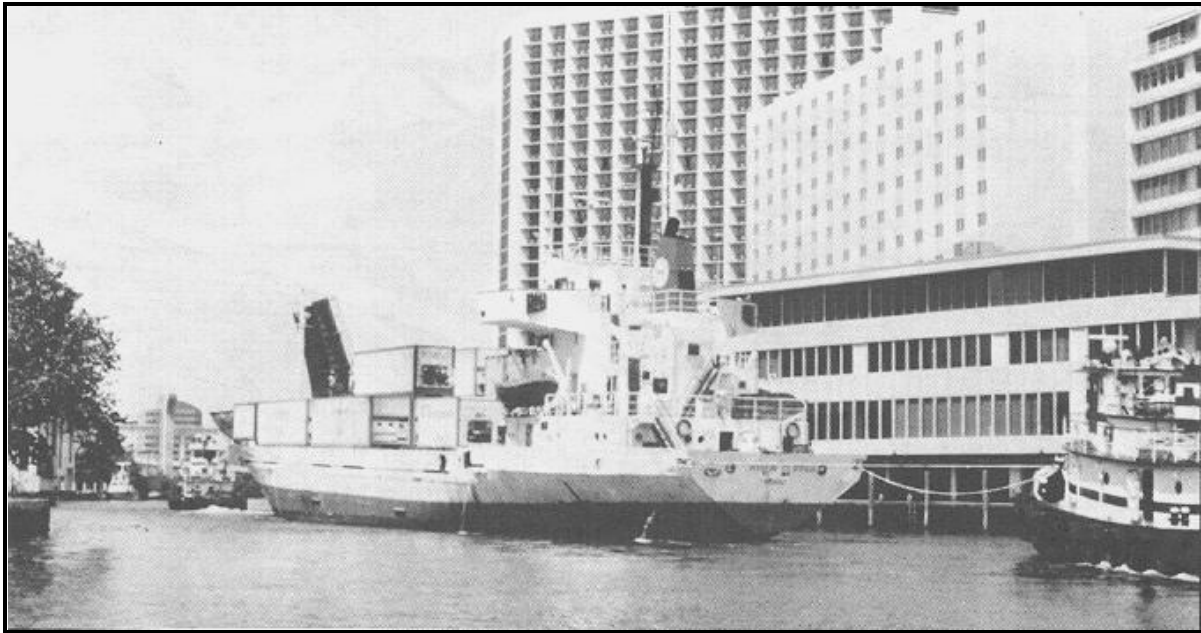

Large commercial vessels like this one have the right-of-way during evacuation from the area.

General Hurricane Information

Hurricane! The word is both feared and respected by knowledgeable mariners and old timers along the U.S. Coastal areas of the Gulf of Mexico and the Atlantic Ocean. Residents of Southeast Florida are constantly alert to the news of tropical storms developing in or headed for the Atlantic Ocean or Caribbean Sea, or Gulf of Mexico. This interest is at its highest during the official hurricane season from June 1st to November 30.

A hurricane is a violent tropical cyclone, with winds of 74 or more miles per hour, which spiral counterclockwise around a relatively calm center known as the "eye" of the storm. At full strength hurricane winds can gust to more than 200 miles per hour as far out as 20 to 30 miles from the eye. Winds of 39 mph and greater can extend 200 miles or more in advance of the hurricane and trail hundreds of miles behind. The greatest threat from hurricane wind is flying debris. Winds may also disrupt electrical power, telephone service, gas, fresh water supplies, and transportation. Tornados are also possible as a spinoff of the hurricane's winds.

The greatest danger of the hurricane, however, is from the storm surge. As the storm approaches and moves across a coastline, storm surge may rise 10 feet or more above normal high tide and usually is accompanied by battering waves which will overcome coastal lowlands. In addition, extensive rainfall associated with the storm, may cause widespread flooding further inland. More than 23 inches of rainfall in 24 hours have been recorded in association with a hurricane.

During the hurricane season, the National Hurricane Center (NHC) in Miami maintains a constant watch for tropical disturbances which could develop into destructive storms. When it appears that a storm is developing, an Air Force reconnaissance aircraft, or one of the National Oceanic & Atmospheric Administration (NOAA)'s research aircraft is sent to the area to make a thorough investigation.

Once a disturbance becomes a depression, the National Hurricane Center will begin issuing advisories. When the depression reaches tropical storm strength it will be given a name. Advisories are then issued every six hours and indicate the storm's location, intensity, speed, and direction of travel. As a hurricane moves toward the mainland, the NHC may issue advisories more frequently.

Severe weather terms in common use

Hurricane Season - June 1 through November 30 is officially designated as hurricane season.

Advisory - A message released by the hurricane center, usually at 6-hour intervals, updating information on the storm or hurricane, including watches and warnings whenever they are in effect. A special advisory is a message given any time there is a significant change in weather conditions or change in warnings previously released. An intermediate advisory updates information in advisories at 2 to 3-hour intervals, whenever a watch or warning is in effect.

Small Craft Warnings - When a hurricane or tropical storm threatens a coastal area, small craft are advised to remain in port and not to venture into the open sea.

Hurricanes are classified by wind strength known as the Saffir/Simpson Scale:

Saffir/Simpson Scale:

Category	Wind
I	74-95 mph
II	96-110 mph
III	111-130 mph
IV	131-155 mph
V	156 + mph

Tropical Depression - A circulation at the surface of the water with a sustained wind speed of 38 mph.

Tropical Storm - Distinct circulation with sustained wind speeds of 39 to 73 mph.

Hurricane - A tropical cyclone that rotates counterclockwise with sustained winds of 74 mph or greater.

Tropical Storm Watch - The alert given when a tropical storm poses a threat to a certain coastal area within 36 hours.

Tropical Storm Warning - A tropical storm is expected to strike within 24 hrs. with sustained winds of 39 to 73 mph.

Hurricane Watch - The alert given when a hurricane poses a threat to a certain coastal area within 36 hrs.

Hurricane Warning - A hurricane is expected to strike within 24 hours with sustained winds of 74 mph or more accompanied by heavy rain and high waves.

Storm Surge - A rise in tide caused by a hurricane as it moves over or near the coastline. It can be much higher than the normal tidal rise, with breaking waves on top.

General Precautions for Boat Owners

The key to protecting your boat from hurricanes or any severe threatening weather is planning, preparation, and timely action. The following precautions and checklists are meant as guides only. Each boat owner needs a plan unique to the type of boat, the local boating environment, the severe weather conditions likely to occur in that region, and the characteristics of safe havens and/or plans for protection. The following preparation and precautionary suggestions are issued as guidelines to be used by the marine community. While these suggestions may not be applicable to everyone in all instances, it is hoped that common sense and good judgment will prevail. **Should even one of the suggestions save a life, prevent an injury, or reduce property damage, our purpose will have been served.**

- 1. Prior to the hurricane season,** develop a detailed plan of action to: secure your vessel in the marina, if permitted, remove your boat from the threatened area, or to take your boat to a previously identified hurricane refuge. Specifically identify and assemble needed equipment and supplies. Keep them together and practice your plan to ensure it works before hurricane season.
- 2. Arrange for a friend to carry** your plans if you are out of town during the hurricane season.
- 3. Check your lease or storage** rental agreement with the marina or storage area. Know your responsibilities and liabilities as well as those of the marina.

Do not remain on your boat during severe weather.

4. Consolidate all records including insurance policies, a recent photo of your vessel, boat registration, equipment inventory, lease agreement with the marina or storage area, and telephone numbers of appropriate authorities, i.e., harbor master, Coast Guard, insurance agent, National Weather Service, etc., and keep them in your possession. They may be needed when you return to check on your boat after the hurricane.

5. Maintain an inventory of both the items removed and those left on board. Items of value should be marked so that they can be readily identified.

6. Before a hurricane threatens, analyze how you will remove valuable equipment from the boat and how long it will take, so you will have an accurate estimate of the time and work involved. When a hurricane is impending, and after you have made anchoring or mooring provisions, remove all moveable equipment such as canvas, sails, dinghies, radios, cushions, biminis and roller furling sails. Lash down everything you cannot remove such as tillers, wheels, booms, etc. Make sure the electrical system is cut off unless you plan to leave the boat in the water, and remove the battery to eliminate the risk of fire or other damage.

NOTE: When wind and seas warrant, marine agencies remove their boats from service and will not be able to rescue foolish boaters.

In addition to these general steps, which should be taken no matter where you plan to leave your boat during a hurricane or other severe weather, the following steps should be taken depending on the option you select.

Trailerable boats

1. Determine the requirement to load and haul your boat to a safer area. Be sure your tow vehicle is capable of properly and adequately moving the boat. Check your trailer tires, bearings and axle should all be in good condition. Too often a flat tire, frozen bearings or broken axle prevents an owner from moving a boat.

2. Once at a "safe" place, lash your boat to the trailer and place blocks between the frame members and the axle inside each wheel. Owners of light weight boats, after consulting with the manufacturer, may wish to consider letting about half the air out of the tires, then filling the boat one-third full of water to help hold it down. (The blocks will prevent damage to the springs from the additional weight of the water.)

3. Secure your boat with heavy lines to fixed objects. Try to pick a location that allows you to secure it from four directions, because hurricane winds rotate and change direction. It can be tied down to screw anchors secured in the ground.

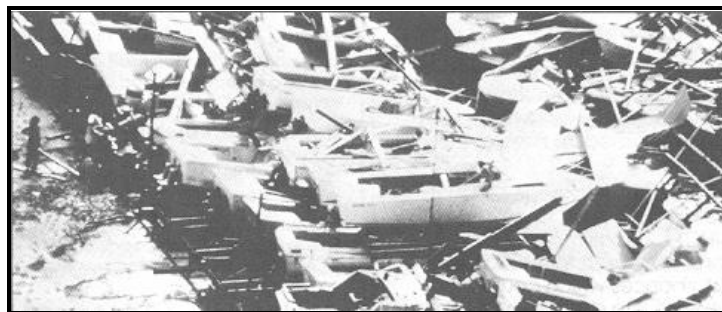

This is what can happen to boat owners who do not take proper precautions.

Non-trailerable boats in dry storage

1. Determine the safest, realistic, obtainable haven for your boat and make arrangements to move your boat there. When selecting a safe location, be sure to consider whether storm surge could rise into the area. Wherever you choose to locate your boat for the duration of the hurricane, lash the boat to its cradle with heavy lines and consider, based on the weight of the boat, adding water to the bilge to help hold it down.

2. Never leave a boat in davits or on a hydro-lift.

Non-trailerable boats in wet storage

The owner of a large boat, usually one moored in a berth, has three options.

1. Secure the boat in the marina berth.
2. Moor the boat in a previously identified safe area.
3. Haul the boat.

Each action requires a separate strategy. Another alternative, running from the storm is not encouraged except for large commercial vessels.

Boats remaining in marina berth

1. Double all lines. Rig crossing spring lines fore and aft. Attach lines high on pilings to allow for tidal rise or surge. Make sure lines will not slip off pilings. Inspect pilings and choose those that seem strongest and tallest and are properly installed.

2. Cover all lines at rough points to prevent chafing. Wrap with tape, rags, and rubber hoses, etc. Install fenders to protect the boat from rubbing against the pier, pilings and other boats.

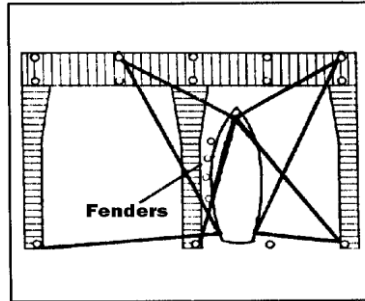

The longer the docklines, the better a boat will be at coping with high tides. It is also essential to double up on all lines and use chafe protectors at any potential chafe points.

3. Assess the attachment of primary cleats, winches and chocks. These should have substantial back plates and adequate stainless steel bolt sizes.

4. Batteries should be fully charged and checked to ensure their capability to run automatic bilge pumps for the duration of the storm. Consider backup batteries. Cut off all devices consuming electricity except bilge pumps.

5. Do not stay aboard. Winds, during any hurricane, can exceed 100 mph and tornadoes are often associated with these storms. First and foremost, safeguard human life.

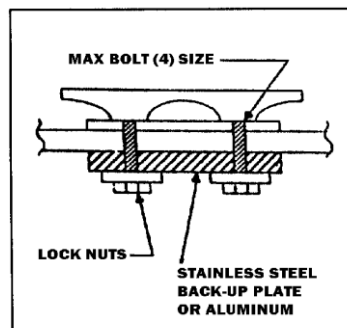

Reinforced and properly backed cleat. Note the washers and the backing plate. These are essential in a hurricane and a good idea in quieter times as well.

Nautical knots



Figure eight



Square or reef knot

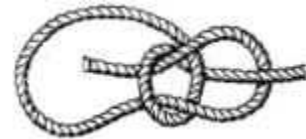

Bowline



Two half hitches



Sheepshank

Specific Precautions for Boat Owners

Marine facilities, marine related service organizations and insurance companies consider it reasonable to expect a boat owner to take the time and effort to plan necessary actions to secure and protect the vessel. The following should be considered in formulating an overall hurricane plan for your vessel. Necessary arrangements should be made in advance. If you will be away, a Captain or caretaker should be designated to carry out your plan.

Prior to hurricane season

1. Make sure your vessel is in sound condition. This includes the hull, deck hardware, rigging, ground tackle, machinery and electronics. Absentee owners should arrange for a boatyard haulout or a supervised inspection of the vessel prior to, and in preparation for, the hurricane season. This includes making sure batteries are charged, bilge pumps are operable and all equipment is secured.
2. Enhance the watertight integrity of your boat, both above and below the water line. Seal windows, doors and hatches if necessary, with duct tape. Shut sea cocks and cap off or plug unvalved through-hull fittings such as sink drains.
3. Inspect the vessel's deck hardware in light of planned mooring arrangements. Assess the size and structural attachment of the primary chocks, cleats, buffs, bollards, and winches. These high load/high stress points should have substantial backing plates and be secured with bolts of adequate size.
4. Special attention should be given to avoiding chafing of mooring lines. Chafing gear that has been proven successful is a double neoprene hose arrangement.

5. Storm moorings, whether at dock or otherwise, should have **doubled lines**. The second set of lines should be a size larger than the normal lines, including spring lines at a dock.

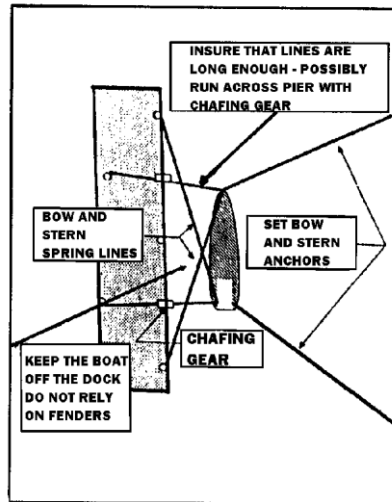

Mooring alongside a dock or barge. Note: Do not allow line to pull sideways on cleat, always lead line along the cleat by use of chocks.

6. Purchase necessary materials ahead of time such as additional lengths of mooring lines, screw anchors, fenders, fender boards, chafing gear, and anchors. These items may not be readily available during the hurricane season or just prior to a hurricane.

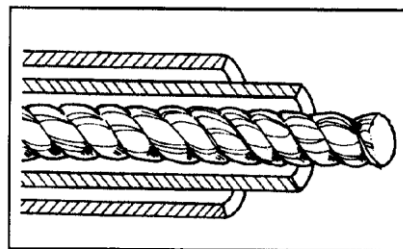

For a super system, if your chocks are large enough, fit a second, larger-diameter hose around another hose that fits snugly to the line. Drill holes in both hoses, and use cord to tie them securely to the line. In a pinch, you can use a single hose.

7. If the vessel is to be unattended during the hurricane season, the vessel should be hauled at a storage yard or on its trailer, if trailerable. Arrangements for wet storage at a protected dock, mooring or marina is another alternative.

8. Make up an inventory of all vessel equipment. Note items to be removed from vessel. Keep a copy of the inventory list on board and ashore.

9. For wet berthing locations, ensure that seawalls and docks are sound, mooring bits and cleats are secure, dock pilings and dolphins are in good condition.

10. At private berthing and dock facilities in residential areas, check with neighbors and other vessel owners in the area. Coordinate safety and mooring arrangement plans.

11. At the marina facilities find out from the dock master or marina management personnel what their hurricane plans and/or procedures are in regard to vessels left at the facility.

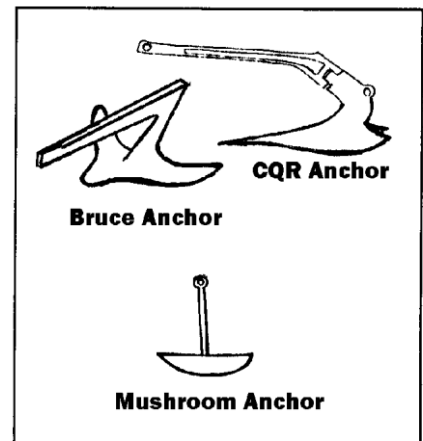

The bruce anchor will bury deeper the harder the boat pulls and hold in a 360 degree rotation. After surviving the storm the anchor may be so deep it will have to be sacrificed.

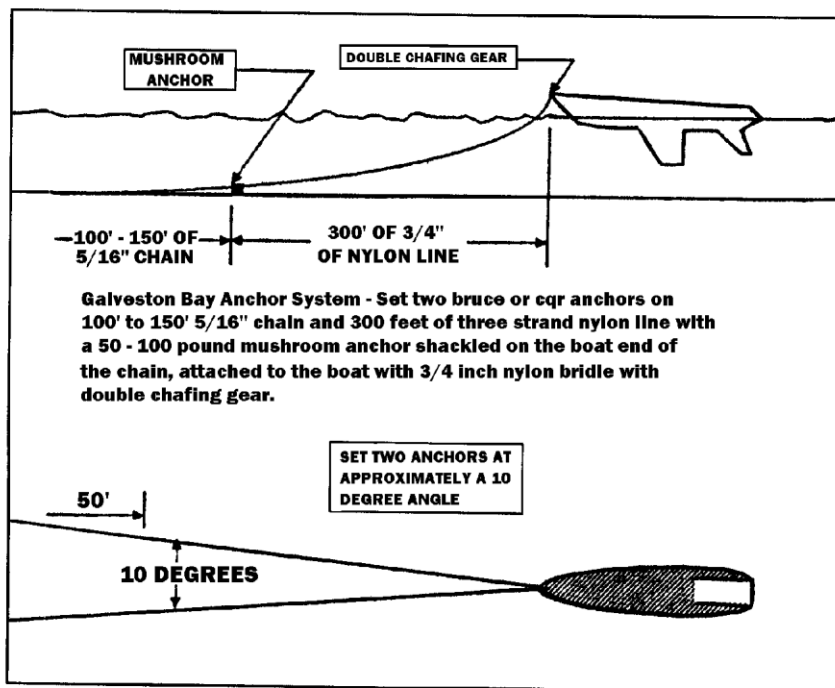

Prior to the hurricane

1. If your plan calls for moving your vessel, and you have sufficient notice, do it at least 48 to 72 hours (or earlier) before the hurricane is estimated to strike the area. This may be before a hurricane watch is issued.

2. Make sure that:

- (a) fuel tanks are full;
- (b) fuel filters are clean;
- (c) batteries are charged;
- (d) bilges are clean;
- (e) cockpit drains are free and clear;
- (f) fire fighting equipment is in good order;
- (g) and lifesaving equipment is in good condition, in place and readily accessible (these items will be secured later).

12. Check with local marine and law enforcement organizations for local plans. This is especially important in boating centers of South Florida where access to inland protected rivers and canals is limited by bridges that may be permanently closed for land evacuation routes when a hurricane warning is issued.

13. If your plan calls for moving your vessel from its current berthing location to an inland waterway location, know your route, your vessel navigation requirements at different tides and the restrictions along the route such as bridges (auto and train) and channels. This is especially important for sailboats.

14. Rehearse your planned vessel movement, including an actual visit to the alternate dock or hurricane mooring/anchoring location. If rental of a protected dock or slip space is required, make arrangements well ahead of time.

15. Be sure that family or key crew members know your hurricane plan or arrangements and that everyone that may be involved knows how to contact you or your designated representative or agent.

16. Key your plan on quick response. Moving a vessel, stripping sails, derigging, and anchoring in seas resulting from 35 mph winds is extremely difficult; impossible in 45 mph winds.

17. Prepare your hurricane plan in writing and make copies of it. Keep a copy on the vessel and at home. Extra copies should also be made for marina or yacht club facilities which may require you to have one on file with them.

18. Make sure your insurance policy is current. Read the policy thoroughly. There is quite a bit of helpful and advisory information in the policy relative to what the vessel owner should and should not do if there is storm or hurricane related loss or damage to the vessel. Understand the coverages, exclusions and your duties as a vessel owner.

One of many possible arrangements that can be used to secure a boat in a hurricane hole.

3. Remove and/or secure all deck gear, portable gear, radio antennas, outriggers, fighting chairs, deck boxes, bimini tops and side canvas/curtains, sails, boom, dorades, extra halyards, canister rafts, and dinghies. Make sure that you secure all hatches, ports, doors, lazarettes and sailboat rudder. (The dinghy may be required to take lines ashore).

4. If your vessel is moored at dock on a canal, river, or in a marina near the ocean, it is possible that with an additional 5-10 feet or greater storm surge, the vessel could take a beating against the dock or even impale itself on the pilings.

5. The best offshore mooring location for a vessel to ride out a storm is in the center of a canal or narrow river where at least doubled mooring lines can be secured to both shores, port and starboard, fore and aft.

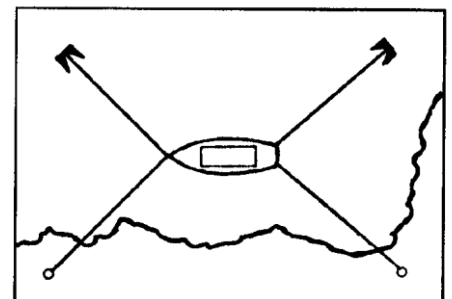

6. Do not raft vessels together at moorings or docks, especially if larger and smaller vessels are involved. The probability of damage to the vessels is greater than if they are moored singly.

7. If the vessel must remain dockside at a private dock or marina, heavy duty fender boards (2" x 6") should be used on a bare wood center piling or otherwise installed to prevent damage. Lines should be doubled and even tripled where necessary to hold a vessel in the center of a berth or off seawall or dock pilings. Preventers should be installed at the top of the pilings so lines cannot slip off the top. Note that nylon line will stretch five to ten percent of its length.

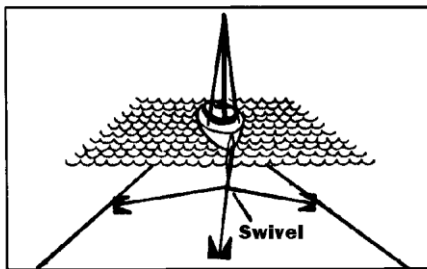

Using three anchors set 120 degrees apart allows the boat to swing and face the wind. This is an especially good technique in crowded harbors because the boat will not swing in as wide an arc as a boat that is riding on only two anchors.

During the hurricane

1. **Do not stay aboard any vessel during a hurricane.** If you have taken all the preliminary precautions previously outlined, you have done all that can be done in anticipation of the storm.

2. Stay in a protected and safe place. Attend to the safety of family, home and other personal property.

3. Stay tuned to news broadcasts and weather advisories concerning the hurricane so that you will know when the danger has passed.

After the hurricane

1. After the hurricane has passed, there may be extensive damage in the area. While checking the condition of your vessel is an important concern, there may be limitations such as flooded roads and downed power lines. A check of the vessel should be made as soon as practicable to determine its condition and security.

2. Other vessels may be upriver behind your vessel mooring location. This may require that you modify your mooring if you are in the center of a canal or stream so that other vessels may navigate past you. If you don't, others may just cut your mooring lines and let your vessel drift, causing more damage than the hurricane.

3. A check of vessel security is important if damage has occurred. One security aspect that must be considered is the prevention of looters or others who feel that a damaged vessel is "abandoned" and thus theirs to take.

4. If there has been any theft or vandalism loss or damage to the vessel, other than storm related, a report should be made to local police or other law enforcement authorities so that appropriate actions can be taken. The incident report number and, if possible, a copy of the incident report should be obtained to substantiate any insurance claim or IRS property loss reporting.

5. If damages are incurred to the vessel, immediate action should be taken to save the vessel and/or equipment and prevent further loss or damage. This action is a requirement of all insurance policies. A vessel owner is expected to take those actions that a prudent "uninsured person" would take to save and preserve his property.

6. If the vessel appears to be unrepairable (constructive total loss), arrangements will still have to be made to remove the hull from any navigable waterway as this will probably be required by government authorities. The vessel should be moved to a yard or salvage facility storage area.

7. If salvage removal of your vessel is required (emergency or otherwise) and you are unable to receive advice from your insurance company, agent, marina or yacht club, screen the salvage contractor for competence and cost. Read the contract, know where your vessel is going, and the level of security provided at the location. Save as much equipment from the vessel as possible.

8. Where vessel damages are repairable, immediate arrangements should be made with a reputable repair yard to have the vessel moved there, if necessary, for repairs. Make a list of repair facilities that you would like to work with. Obtain estimates before proceeding with repairs. Those who act quickly will be back in the water first.

Specific Precautions for Marina Owners

Marina operators, yacht dealers, boat builders, and boat repair yards should consider the following information in formulating an overall hurricane plan for their facility. Since facilities, circumstances and exposures vary throughout the county, adaptation of these suggestions to specific situations may be necessary.

Prior to hurricane season

1. A formal hurricane plan should be developed and distributed to all employees. Facility personnel will have homes, family and property of their own to consider. They must be made aware of their work related duties and responsibilities so that they plan accordingly.
2. Know your physical plant facilities, operations services, equipment, and housekeeping. Make assignments of personnel to be responsible for areas and operations of the facility. Designate team units to be responsible to key people.
3. Review plans and procedures with co-tenants or subcontractors in multiple occupancy facilities.
4. Review your facility's "seasonal" operations or activities during the hurricane season and consider ordering supplies, stocks, and vessel inventory items accordingly to keep exposures as low as possible.
5. Consider the number of permanent, transient, new or brokered vessels that may be on hand in your care, custody and control at any period of time during the hurricane season. Can you secure all vessels at your facility or will vessels have to be moved to inland protected areas? How and by whom? Where? These questions are best answered in the calm, long before the storm.

6. Determine your policy on non-owned vessels in your care, custody and control at your facility or elsewhere. Communicate your position to vessel owners, preferably in written form as a notice or as part of the mooring, listing or work order agreement or contract.

Know all the vessels and their owner, captain, or caretaker. You should have on record the home and business phone numbers and addresses of the vessel owner or their designated representative. Consider having vessel owners file their hurricane plan, in writing, with you.

7. Conduct a complete facility housekeeping and "field-day" or "field-week" operation sometime in the spring or just prior to the hurricane season, to police and clean up all open areas and structures within the facility. This should include, but is not limited to, the following:

- (a) Remove all debris, trash and unnecessary items from open areas.
- (b) Store or otherwise secure all materials and supplies.
- (c) Inspect and service as necessary all building walls, roofs, windows, doors, docks, pier, wharfing or slipfingers, pilings, electrical and lighting installations, fuel and natural gas supply and dispensing equipment, both portable and fixed fire fighting equipment, mobile lifts, hydrolifts, and railways.

8. Order and stock as necessary emergency equipment and supplies the facility warrants such as extra mooring lines, lumber for fender boards, chafing gear, screw anchors, flashlights, batteries, portable generators, electrical and manual bilge pumps, and hull patching or repair supplies.

Prior to the hurricane

Even the smallest marine facility operation has numerous tasks and precautions that must be taken in preparation of a hurricane. The extent of the tasks and the number of personnel available will determine the amount of time required to complete the preparation. However, 72 hours is probably the minimal time allowable in most instances to undertake the following.

A. 72-48 hours prior to Small Craft Warning conditions.

1. Notify personnel that the facility is on a hurricane alert. Personnel should commence preparations for putting the hurricane plan in action.
2. Any mobile or waterborne operations personnel should be put on standby to start securing operations within the next twenty-four (24) hours.
3. Begin facility protection preparations by policing all yards, marina and dock areas. Stow away or secure loose equipment.
4. Secure all flammable, explosive or other hazardous materials, such as compressed gas cylinders, in a safe, protected secure area.
5. Dry storage or other facilities with outside "racks" for small boat and trailer storage should consider removing vessels from racks and securing them elsewhere.
6. Facilities with inside "rack" storage in a building may provide sufficient protection unless in a lowland area where evacuation of all vessels may be necessary.
7. Take down large signs, antennas or other removable items subject to wind damage.

8. Facility protection precautions should commence at this time. Storm shutters or other protective equipment should be made ready and/or installed for use.
9. Process and mail all paperwork that can be completed immediately. Set all new paperwork aside to be completed after the hurricane.
10. Remove expensive equipment or products to inland warehouses for storage.
11. Reduce inventories as much as possible and delay ordering materials, stocks or supplies.
12. All facilities should begin contacting vessel owners or their representatives in order to begin removing vessels from the facility, if required.

B. 48-24 hours prior to Small Craft Warning conditions.

1. Lowland locations that are evacuating personnel and equipment should be completing securing operations. All dock structures, field buildings and offices should be secured. Trailers should be evacuated. All electrical power supplies should be secured by turning off at the main power switch. All natural gas should be turned off at the main valve. All fuel supply tanks and lines should be secured at the shoreside installation. All electric motors, pumps and like equipment at or below ground level should be disconnected and protected or placed in a safe location. If fresh water is supplied from city water lines, turn off the supply at the meter. Notification to location manager, or local police should be made when evacuation is complete and the location secured.
2. All vessel removal operations should be well underway and completed during this twenty four hour period. Plans for securing remaining vessels should commence.

3. As the departing vessels are fueling, facility vessels and vehicles should also be topped off, as necessary, in preparation for securing all fueling operations and equipment. Loss of electrical power during a hurricane may disrupt fuel supplies after the storm.
4. Any equipment such as forklifts, trucks, travel lifts, mobile cranes, and workboats that may not be needed in storm preparations, should be secured in protected areas, shops or warehouses.

C. 24-0 hours prior to Small Craft Warning conditions.

In these hours prior to the projected arrival of the hurricane, the "Hurricane Warning" has been issued and it is highly likely that the hurricane will landfall near your facility. The following activities should be in progress or nearing completion so that most personnel can be released in the next twelve hours.

1. All vessel protection and securing operations should be completed with a final check of doubled mooring lines, tied off with sufficient slack and fender boards and/or other protective equipment in place.
2. Employees who are not staffing facilities during the storm should be released no later than twelve hours prior to the storm. Instructions for reporting back to work after the storm should be given.
3. Whether staffing or evacuating the facility, insure that all perimeter access points in the form of fences, gates, and building doors are locked and secured.
4. All facility precautionary preparations should be completed twelve hours prior to the hurricane's arrival.
5. No personnel should be allowed to stay on any vessel during the hurricane.

During the hurricane

1. Stay in a protected and safe place inland if possible.
 2. For facilities remaining staffed, extreme caution should be exercised if outdoor activities become necessary.
 3. No one should attempt to move or re-secure a loose vessel or equipment during the storm period.
 4. Stay tuned to news and weather broadcasts concerning the hurricane's movement so you will know when the danger has passed.
 5. **Do not venture out during the "eye" or lull in the hurricane.**
-

After the hurricane

1. The hurricane may cause extensive damage, flooded roads, downed power lines, and washed out beach or river areas. While checking the condition of your facility is of a main concern, there may be limitations which may impede you from accessing it.
2. As personnel return to the facility and begin the preliminary damage assessment process, they should be aware of the following potential problems:
 - (a) Beware of snakes when going into grassy areas or other locations. Personnel should wear boots and be cautioned to look where they place their feet and hands.
 - (b) Be aware of possible downed electrical wires which should be considered "Hot" and avoided until the power company or electrical maintenance personnel are notified. Although your house or boat may be without power, generators may be operating thus the electrical lines will be charged.

- (c) Checks should be made for leaking natural gas by smell only, not with matches or candles.
- (d) Facility fueling docks and tanks should be checked for leaking gasoline or diesel fuel.
- (e) Electrical equipment of the facility that has been submerged in water should not be started until it has been checked and repaired as necessary.
- (f) Broken sewer or water mains should be reported immediately to either the utility company responsible for repair or to the maintenance personnel if owned and maintained by the facility.
- (g) Building, shop and dock electrical wiring should be checked completely prior to turning on the main power switch.
- (h) Wet electrical appliances, such as hot plates, toasters, calculators, typewriters, etc. should be inspected and repaired or replaced as necessary, prior to operation.

3. Prepare a written assessment of damages as soon as possible. Estimate damages to docks and piers and other harbor facilities:
cranes, mast hoist, boat sheds, toilets, showers, lockers, Harbor Master's office, fuel dock and office, electrical transformers, electrical service, and telephones.

4. If there has been any theft or vandalism loss or damage to the facility, other than storm related, a report should be made to local police or other law enforcement authorities so that appropriate actions can be taken. The incident report number and, if possible a copy of the incident report, should be obtained to substantiate any insurance claim or IRS property loss reporting.

5. While it is understandable that immediate repairs may need to be undertaken, all actions taken during the course of repairs prior to any insurance adjustment should be properly documented and filed. In the case of facility property damages, appraisers assigned by the insurance company will be involved in assisting with the adjustment. Insurance companies will establish storm claim offices to handle the numerous claims after a hurricane strikes.

In catastrophic situations, extra personnel are called in to handle volumes of claims.

6. It is obvious that third party vessel owners, captains, caretakers and others with vessel interests will inquire as to the status of their vessel. These inquiries should be fielded as best as possible, especially if there is no damage to their property. Notification of any vessel damage should be made as soon as possible.

7. While vessel owners may want to return to marinas or yard facilities as soon as possible, they should be advised as to the situation at the facility and as to the availability of berthing facilities for their vessel. If damages preclude the facility from providing a berthing space for the vessels, owners should be so notified and advised as to when the facility may be available to provide a berth.

8. If the facility is relatively undamaged, then efforts should be made to become operational and provide facility services to those who are not so fortunate.

9. Controlled access and/or security at a facility may be required. Plan how to handle:

- (a) members and non-members in the case of yacht clubs,
- (b) tenants and non-tenants in the case of marinas or other facilities,
- (c) radio, television and press representatives,
- (d) outside salvage contractors, repairers, estimators, surveyors, adjusters, and appraisers.

There may be many other actions and precautionary measures that can be taken prior to, during, or after a hurricane strikes an area. The above may not cover all actions that should be taken, but is provided as a guideline and checklist that can be a starting point for developing a hurricane plan.

If there are specific measures or precautions unique to your operations, then fit them into the checklist when preparing the plan for your facility.

Only by being prepared in advance will you be able to reduce loss and damage as a result of a hurricane.

Tying to cleats and pilings



Correct method of making fast to a cleat



Incorrect method of making fast to a cleat

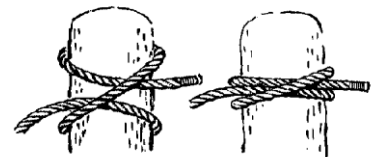

Clove hitch

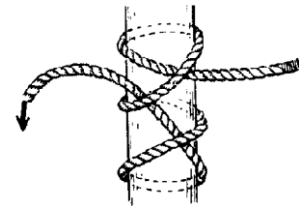

Rolling Hitch

General Procedures to Process Vessel Claims

Once you determine you have a loss, the following steps should be taken to process your claim:

1. For the record, photograph the damaged vessel and make a list of all damages and suspected problems. If the vessel is in peril, take all necessary steps to preserve the vessel and prevent further damage. Do not begin repairs other than those necessary to prevent further damage.
2. Promptly call your insurance agent to report the claim or loss. Estimate the percentage of damage — cosmetics, water damage, total loss, etc.
3. Contact repair yards to get estimates for repairs. You do not have to wait for an adjuster/surveyor to get estimates.
4. An adjuster, insurance company surveyor or independent surveyor acceptable to the insurance company will be instructed to survey the damaged vessel. The boat owner can elect to hire a second surveyor, at his own cost, to conduct an independent survey of the vessel. The boat owner should arrange to accompany the surveyor on the initial damage survey.
5. Have your inventory list, receipts, inventory pictures, pictures of damages and repair estimates ready for inspection by the adjuster/surveyor. You will need to provide both a "proof of loss" and "release/payment order".
6. After conducting the survey, the surveyor files a surveyor's damage report with the insurance company, and sends a copy to the boat owner, if required.
7. The boat owner files a statement of loss with the insurance company explaining what took place, when, where and why. It includes specific lists of known damages along with sketches or drawings.

8. In the event of a dispute, the boat owner will hire a second surveyor/adjuster, at the boat owners expense, to represent the owners side of the dispute. A third party will be designated to listen to both sides and arrive at a decision.
9. If the boat owner agrees on the estimates and companies to do the repairs, the insurance company issues a check with both the repair firm and boat owner/mortgagee listed as payees on the check.
10. When the work is completed to the boat owner's satisfaction and approval, the check is co-signed and the repair firm is paid.
11. Keep in mind that, with all the confusion accompanying the aftermath of a hurricane, the underwriters will first settle claims having all the appropriate paperwork completed.
12. If a total loss of the vessel exists, a check is issued by the insurance company to the boat owner and mortgagee, usually for an amount equal to the agreed value or the fair market value of the vessel.
13. In the event of a total loss, be prepared to surrender the vessel's documentation papers, original insurance policy, any remaining equipment and the damaged vessel.

Sunk Vessels!

Immediately contact a marine towing company or contractor to raise your vessel out of the water. This will help avoid a total loss of your vessel.

Remember!!

If a vessel is insured, and damages have occurred, a report of loss and/or damage should be made to the insurance agent and/or company as soon as possible. A telephone call will suffice to put them on notice. This should be followed up with a written notice. Provide all the details that you can on this first notice, such as:

- (a) exact location of vessel,
- (b) structural condition of vessel (e.g., holes in hull or minor damages),
- (c) did the vessel partially sink and is the machinery and/or interior wet, etc.
- (d) must the vessel be removed immediately; if so, to what location.

Be aware !!!

Insurance companies will have surveyors and adjusters in the area to assist and work with their policy holders. In locations designated as disaster areas, there will be insurance teams and claims offices established. While surveyors, adjusters, company representatives, and many repair facilities will try to work with you, only you have the right and authority to determine what is to be done to or on your vessel. There will be many boat owners with damaged vessels and repair facilities will be very busy. You will have to do the necessary preliminary work quickly to get your vessel repaired.

Boat Owner's Preparation Worksheet

Use this worksheet, after reading the material in these guidelines, to adapt it to your own circumstances. Then be sure to distribute copies to your alternates as well as your marina owner/manager.

Boat's Name: _____ **Length:** _____ **Model:** _____
Name: _____
Address: _____
City: _____ **State:** _____ **Zip:** _____
Phone Day: _____ **Night:** _____

Alternates (If you are not available):

Name: _____
Address: _____
City: _____ **State:** _____ **Zip:** _____
Phone Day: _____ **Night:** _____
Has Boat Keys? _____ **Access to Hurricane Equipment?** _____
Name: _____
Address: _____
City: _____ **State:** _____ **Zip:** _____
Phone Day: _____ **Night:** _____
Has Boat Keys? _____ **Access to Hurricane Equipment?** _____
Boat's Current Location: _____

Planned Location During Hurricane: _____

If at a Dock: Slip #

Additional Lines No: _____ **Length:** _____ **Size:** _____
Chafe Gear: _____ **Fenders:** _____

If at a Hurricane Hole:

Travel Time by Water From Present Location: _____
Are There Any Bridges? _____
If Yes, Will They Open Prior to Hurricane? _____
Has Owner of Surrounding Land Been Contacted? _____
How Will the Skipper Get Ashore? _____
Type of Bottom: _____ **Depth:** _____
Additional Anchor Needed: No: _____ **Size(s):** _____
Type(s): _____
Additional Lines: No: _____ **Length:** _____ **Size:** _____
Additional Chain: No: _____ **Length:** _____ **Size:** _____
Chafe Gear: _____ **Swivel:** _____ **Shackle(s):** _____

If at a Mooring/Anchorage:

Has Mooring Been Inspected Within the Last Six Months? _____
How Will the Skipper Get Ashore? _____
Type of Bottom: _____ **Depth:** _____
Mooring Line Should Be Extended _____' to Increase Scope
Additional Anchors Needed: No: _____ **Size:** _____
Type(s): _____
Additional Lines: No: _____ **Length:** _____ **Size:** _____
Additional Chain: No: _____ **Length:** _____ **Size:** _____
Chafe Gear: _____ **Swivel:** _____ **Shackle(s):** _____

Diagram of Proposed Hurricane Docking/Mooring Arrangement:

If at a Hurricane Hole:

Is Boat Already Stored Ashore? _____

If No, What Arrangements Have Been Made for Hauling? _____

Storage Location: _____
Contact Name (Marina/Property Owner) _____
Phone No: _____

List All Equipment Needed Aboard to Prepare Boat:

<i>Equipment</i>	<i>Current Location</i>
1. Extra Lines	_____
2. Chafe Protectors	_____
3. Fenders	_____
4. Anchors	_____
5. Swivels	_____
6. Shackles	_____
7. Duct Tape	_____
8. Plugs(Exhaust Port)	_____
9. _____	_____
10. _____	_____

List Equipment to Be Stripped From Boat

<i>Equipment</i>	<i>Storage Location</i>
1. Electronics	_____
2. Dinghy	_____
3. Outboard/Fuel	_____
4. Sails	_____
5. Bimini	_____
6. Galley Fuel	_____
7. Ship's Papers	_____
8. _____	_____
9. _____	_____
10. _____	_____

Hurricane Plan Final Checklist

- | | |
|---|---|
| <input type="checkbox"/> Arrange Dock/Anchor Lines | <input type="checkbox"/> Strip Bimini, Sails, Life Rings Etc. |
| <input type="checkbox"/> Add Chafe Protection | <input type="checkbox"/> Disconnect Shore Power |
| <input type="checkbox"/> Use Extra Fenders/
Fenderboards as Needed | <input type="checkbox"/> Close Fuel Valves |
| <input type="checkbox"/> Put Duct Tape on Windows
and Hatches | <input type="checkbox"/> Lock Boat |
| <input type="checkbox"/> Insert Plugs in Engine Ports | <input type="checkbox"/> Notify Marina Manager |

Summary

Important Points to Remember!

- ***Develop your hurricane plan early. Only you can be responsible for your plan.***
- ***Make all arrangements for moving and securing your vessel prior to hurricane season.***
- ***There are insufficient safe havens for all vessels in the county. Those who act early will fare the best.***
- ***Do not stay on your vessel, or attempt to move or secure your vessel after small craft warnings have been posted.***
- ***Do not be fooled by the lull or calm as the eye passes. The second half of the storm will soon strike with full intensity.***
- ***Marine agencies will pull their vessels from the water when wind and seas warrant. They will not risk their lives to rescue careless boaters.***
- ***Stay tuned to all broadcasts and official bulletins until the storm has fully abated.***
- ***Do not return to your vessel until the hurricane has cleared your area and you are told its OK to return.***
- ***Your life is more valuable than your property. Do not allow yourself to become a hurricane statistic!***

Important Contact Numbers

You should obtain the following contact numbers in advance so that you have them when they are needed.

Insurance Agent _____

Marina Dockmaster _____

U.S. Coast Guard _____

Local Marine Unit _____

Emergency Management Office _____

Local Fire Department _____

Local Police Department _____

Florida Fish and Wildlife
Conservation Commission _____

Towing Company _____
