

1
ADD'S
TYP. H.C. PARKING STRIPING
NTS.

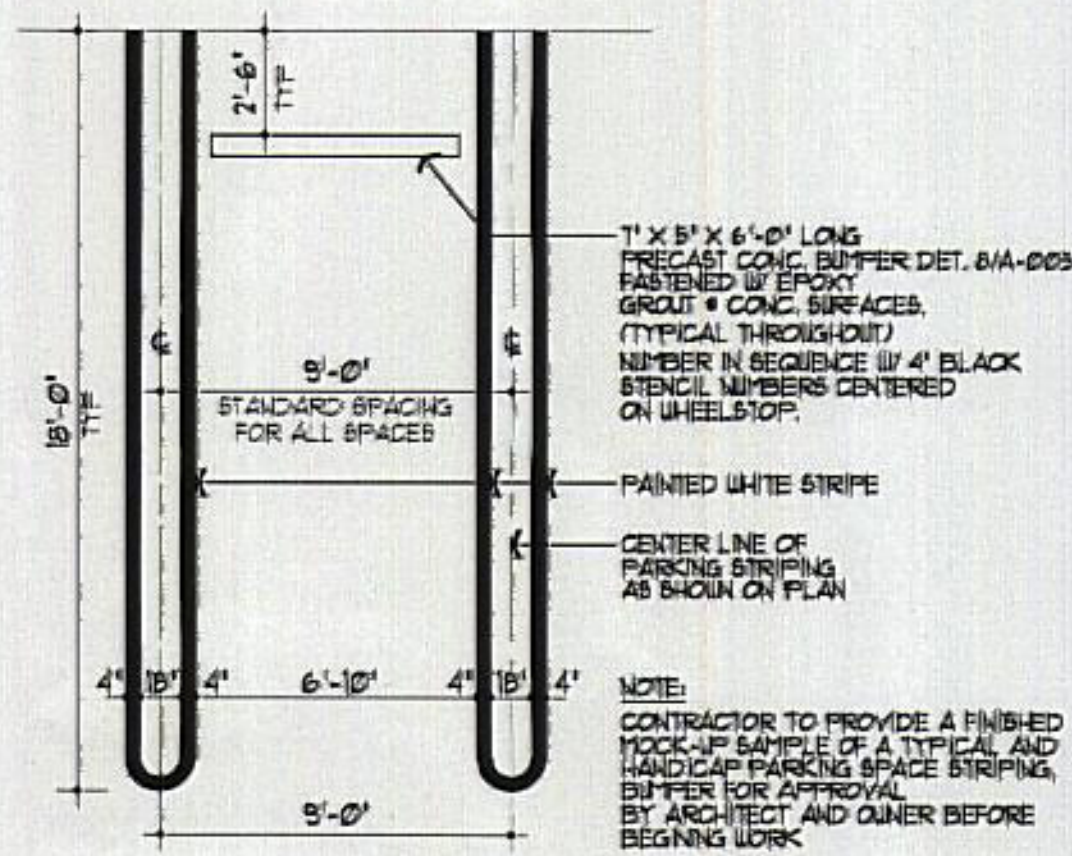

2
ADD'S
TYP. PARKING STRIPING
NTS.

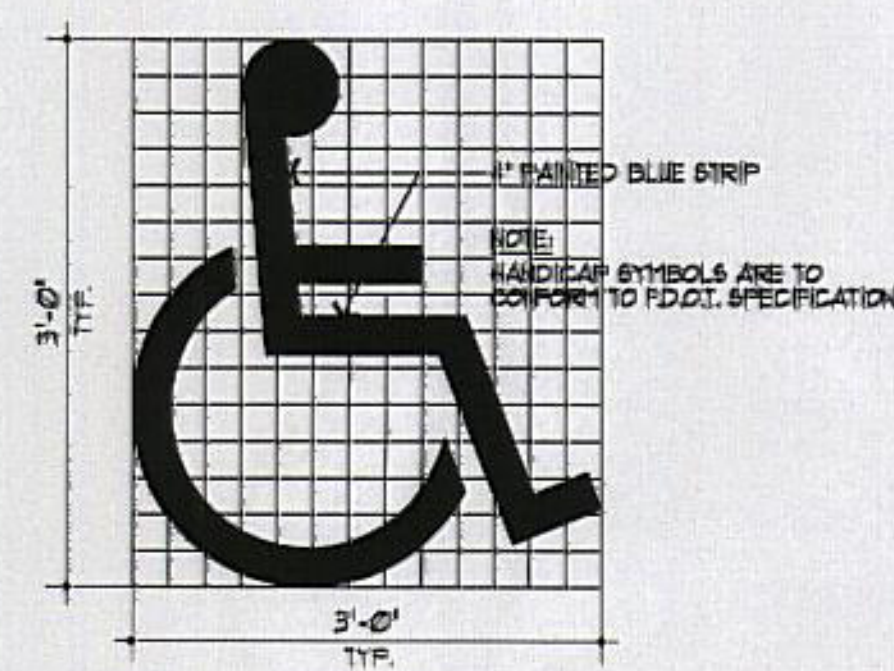

3
ADD'S
TYP. HANDICAP SYMBOL
NTS.

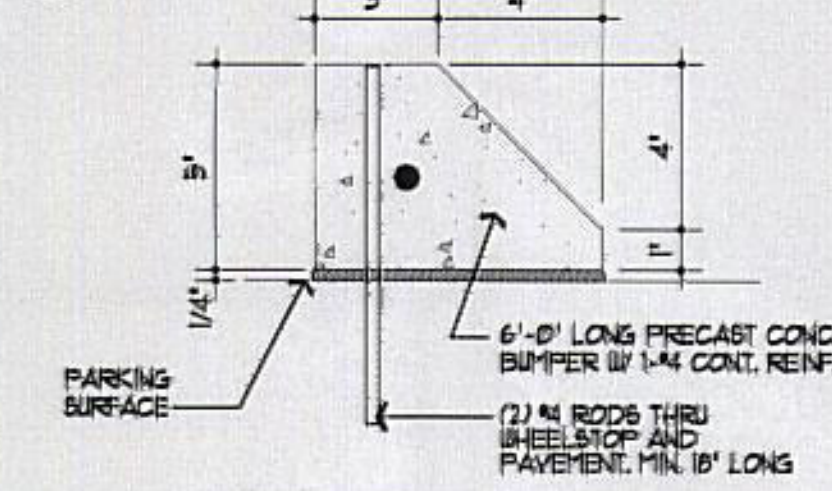

4
ADD'S
TYP. WHEELSTOP @ ASPHALT
NTS.

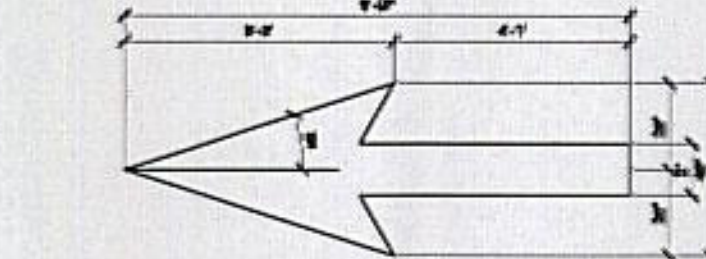

10
ADD'S
TYP. TRAFFIC ARROW
NTS.

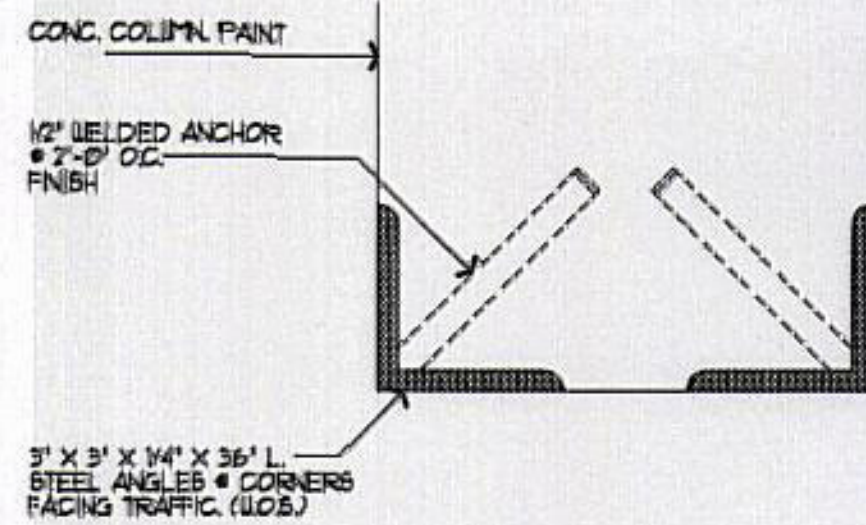

6
ADD'S
COLUMN GUARD SECTION
NTS.

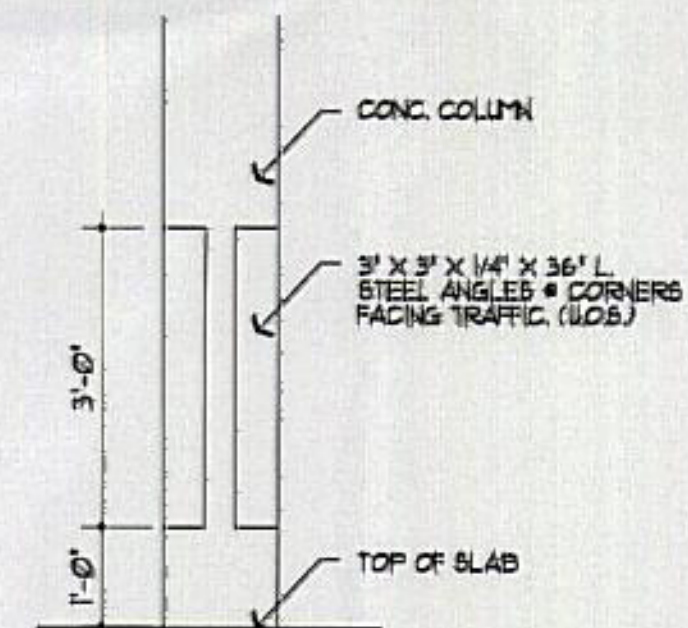

7
ADD'S
COLUMN GUARD ELEVATION
NTS.

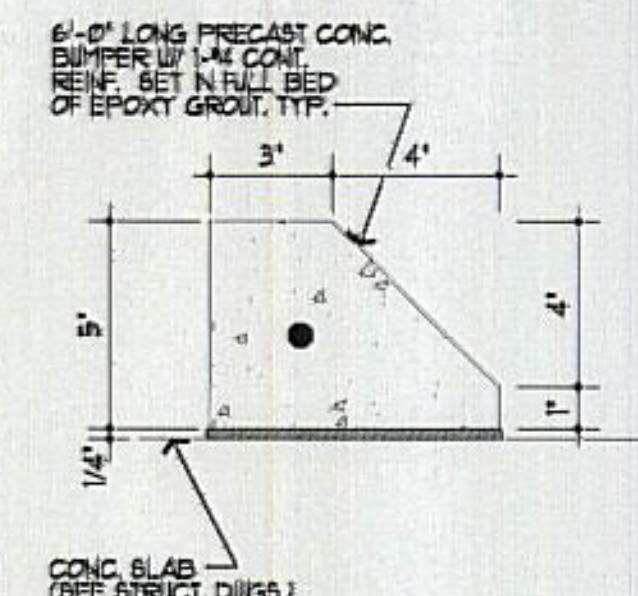

8
ADD'S
TYP. WHEELSTOP @ SLAB
NTS.

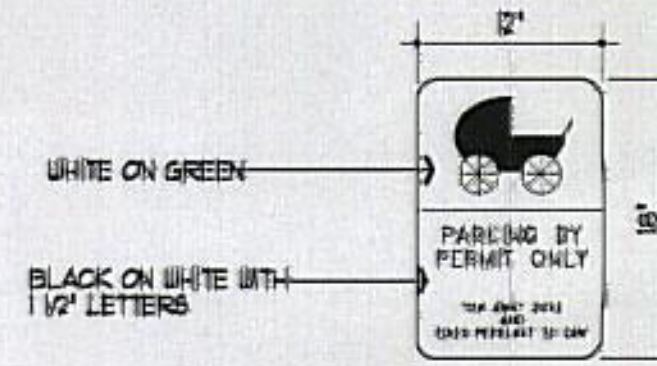

11
ADD'S
TYP. STROLLER SIGN
NTS.

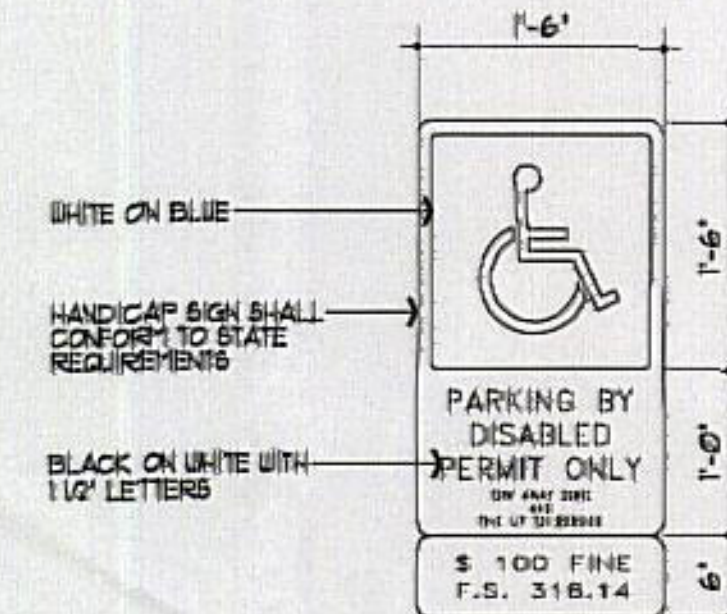

\$ 100 FINE
F.S. 318.14

SIGN NOTES:
1. PROVIDE SIGN POSTED AT LEAST 5' FEET HIGH ON WALL. SIGN MUST BE POSTED WITH THE BOTTOM NO LOWER THAN 7' FEET IF PEDESTRIANS ARE LIKELY TO PASS CLOSE TO SIGN.
2. PROVIDE ONE SIGN FOR EACH HANDICAP SPACE.
3. PROVIDE SIGN ON POST WHERE WALL MOUNTING IS TOO FAR FROM HANDICAP SPACE TO BE EASILY SEEN.
FTP-25
1'-0" X 6'
1'-0" RADIUS 3/4" BORDER
1" BEVELS C
WHITE BACKGROUND
BLACK LEGEND 4 BORDER
SUPPLEMENTAL PANEL FOR THE FTP-25 AND FTP-26 SIGNS

5
ADD'S
TYP. HANDICAP SIGN
NTS.

SIGN NOTES:
1. PROVIDE SIGN POSTED AT LEAST 5' FEET HIGH ON WALL. SIGN MUST BE POSTED WITH THE BOTTOM NO LOWER THAN 7' FEET IF PEDESTRIANS ARE LIKELY TO PASS CLOSE TO SIGN.
2. PROVIDE ONE SIGN FOR EACH STROLLER SPACE.
3. PROVIDE SIGN ON POST WHERE WALL MOUNTING IS TOO FAR FROM STROLLER SPACE TO BE EASILY SEEN.

Oscar Familia & Associates
Design Consultant
4444 S.W. 77TH AVENUE
SUITE 204 MIAMI FLORIDA 33155
PHONE: (305) 445-2124
FAX: (305) 441-2743
EMAIL: oscar@ofa.com

J.R.F. ARCHITECT
JOSE E. FIGUEROA
REG. # 3608
3417 S.W. 147TH AVENUE
MIAMI, FLORIDA 33175
TELEPHONE: (305) 226-5638

MSTM CONSTRUCTION, Inc.
Montserrat S. Martinez
General Contractor
CCC # 058728
4630 W. University Dr.
Coral Springs, FL 33067
www.mstmconstruction.com
MSTM.construction@comcast.com
P.H. 954-729-6898
Fax: 954-345-1566

INTERIOR AND EXTERIOR REMODELING EXISTING BUILDING FOR:
PEDIATRIC RESPIRATORY CENTER
DR. JORGE SALIENT
500 FEDERAL HWY NORTH PALM BEACH, FLORIDA
TELEPHONE: (954) 729-6898

[Signature]

REVISIONS:

1-	
2-	
3-	

DATE: MARCH 2008
SCALE: SHOWN
DRAWN: O.P. & P.L.
JOB NO. 0808-SALIENT

SP-3
SHEET NO. 1 OF

RECEIVED
FEB 10 2008